



# 141-M3M

## Power feeder

*Operating instructions*



Distributor:  
IGM nástroje a stroje s.r.o.  
Ke Kopanině 560, 252 67, Tuchoměřice  
Czech Republic, EU  
Phone: +420 220 950 910  
E-mail: [sales@igmttools.com](mailto:sales@igmttools.com)  
Website: [www.igmttools.com](http://www.igmttools.com)

2022-07-12

141-M3M IGM Power Feeder Manual EN v2.4.00 A4ob



# Operating instructions EN

**Please read this manual thoroughly and follow the safety instructions in it! Technical changes and printing errors reserved!**

Dear customer,

This manual contains important instructions and information for the installation and proper use of the M3M Power Feeder.

This manual is part of the machine and therefore it should not be kept elsewhere than in the vicinity of the machine so that you can be consulted at any time by you or other persons operating the machine.

## **Please read and follow the safety instructions!**



Carefully read these instructions before using the machine. Operation of the machine will be simpler and you will also lower the risk of injury while eliminating the probability of incorrect operation and possible damage to the machine.

Because of our policy of constant improvement, the design, construction or pictures may differ slightly. Should you discover any mistakes, please contact us at [podpora@igm.cz](mailto:podpora@igm.cz)

<b>TABLE OF CONTENTS</b>		<b>PAGE</b>		
1.	DECLARATION OF CONFORMITY	2	5.2.1 Fastening to a machine	4
2.	WARRANTY SERVICE	3	5.2.2 Feeder assembly	5
3.	SAFETY INSTRUCTIONS	3	5.3 Power supply	6
3.1	Notice	3	5.4 Dust extraction	6
3.2	General safety instructions	3	6. SET-UP AND ADJUSTMENT	6
3.3	Risks	3	6.1 Basic movements of the feeder	6
3.4	Important safety notifications	3	6.1.1 Feeding from above	7
3.5	Safety rules	3	6.1.2 Feeding from the side	7
4.	SPECIFICATIONS OF THE MACHINE	4	6.2 Controls	7
4.1	Machine description	4	7. OPERATING THE MACHINE	7
4.2	Technical data	4	8. MAINTENANCE AND CONTROL	7
4.3	The package includes	4	8.1 Replacing rollers	7
5.	TRANSPORT, UNPACKING AND ASSEMBLY	4	8.2 Lubrication	8
5.1	Přeprava a vybalení	4	9. MALFUNCTION ASSISTANCE	8
5.2	Assembly	4	10. PROTECTION OF THE ENVIRONMENT	8
			11. ACCESSORIES (SPARE PARTS)	8

## **1. DECLARATION OF CONFORMITY**

The undersigned: IGM nástroje a stroje s.r.o.

Address: Ke Kopanině 560

Tuchoměřice, Praha-západ, PSČ 252 67

Czech Republic, EU

Tel. +420 220 950 910

### **Certifies**

Product: **Power Feeder**

Type: M3M

Manufacturer: CO-MATIC Machinery Co., Ltd., No.

473-16, San Feng Road, Houli District, Taichung City,

Taiwan, R.O.C. 42156

We declare under our sole responsibility that the product described in this manual is in conformity with the following standards: EN ISO 12100, EN ISO 13857, EN 349, EN 953, EN 60204-1, EN ISO 11202, EN 55014-1, EN 55014-2 with the provisions of Directives 2006/42 / EC, 2004/108 / EC, 2006/95 / EC, 2002/95 / EC. EN 55014-1, EN 55014-2 and is in accordance with the 2006/42/EC, 2004/108/EC, 2006/95/EC, 2002/95/EC.

Signed: Ivo Mlej  
Managing Director



## 2. WARRANTY SERVICE

The warranty is subject to Terms and Conditions and Warranty Conditions of IGM nástroje a stroje s.r.o., the current version of which are available at [www.igmtools.com](http://www.igmtools.com).

## 3. SAFETY INSTRUCTIONS

### 3.1 Notice

**Warning:** failure to comply with these rules can result in the risk of serious injury.

This machine is intended for feeding wood to be cut. Working with other materials is not permitted but can be allowed after consultation with the manufacturer. Comply with the minimum age limits specified by law. The machine may only be used when in perfect technical condition.

In addition to the operating instructions read the safety instructions and also comply with any and all special regulations of your country. You should adhere to the generally recognized technical and safety rules concerning the operation of woodworking and metalworking machinery.

The manufacturer or the supplier is not responsible for any damage resulting from improper use. Every user is responsible for their own actions.

### 3.2 General safety instructions

The machine can pose danger when improperly operated.

Completely read the operating instructions before working with the machines and follow all the instructions in this manual.

Keep this user manual clean and protect it from dirt and moisture; in case of re-selling, pass the manual onto the new owner.

Any alterations or changes to the machine are prohibited.

Daily try out if the machine runs smoothly and check the function of protective covers before operating the machine. Repair any malfunctions or deficiencies found on the machine.

A damaged protective cover must be replaced immediately. The machine may only be used when in perfect technical condition.

Use a hairnet or a hat to protect long hair. Wear tight-fitting clothes, remove all bracelets, rings, necklaces or ties. Wear work boots only, do not wear casual shoes or sandals during work. Abide by the regulations for personal protection.

Always wear safety eyewear. Always use hearing protection. The tools are sharp and may improper handling may lead to serious injury, always work carefully. Keep in mind the necessary space for operation when installing and positioning the machine. The machine must stand on a stable surface

and must be adequately lit.

Always use respiratory protection when working in a dusty environment.

Make sure you have good lighting.

Make sure the power cord is not in your way when working. Keep your work area clean. Never touch the machine when it's running.

Make sure you are concentrating and paying attention. Use caution. Never work under the influence of drugs and/or alcohol.

Make sure there are no children around when working with the machine. Never leave the machine unattended. Always switch the machine off when leaving the workspace.

Watch your fingers and other body parts when working. Never walk away from a machine without protective guards.

Do not place anything on the machine.

Electrical connection malfunctions can be repaired by an electrician only.

Damaged electric cord must be replaced immediately. Any adjustments and maintenance may be carried out when the machine is disconnected from the power source.

### 3.3 Risks

Risks may arise even during proper and prescribed use of the machine.

Danger of a workpiece flying off. Beware of noise and dust.

Wear eye, ear and dust protection. Use a suitable dust extraction device!

Watch out for damaged electrical cords.

### 3.4 Important safety notifications

Do not use the feeder in a dangerous environment. Keep your workspace well ventilated and lighted, avoid wet or damp environments. Only operate the machines under temperatures ranging from +5°C to +40°C.

### 3.5 Safety rules

The tool must reach working speed before feeding.

Do not overload the machine by feeding material too quickly.

ALWAYS keep your hands away from rotating parts.

Provide additional support and stability for larger workpieces. Always switch off the feeder first, only then switch off the machine that is being fed material.

Always disconnect the power cord before any repairs or adjustments.

## 4. SPECIFICATIONS OF THE MACHINE

### 4.1 Machine description

- 1 anchoring bolt
- 2 feeder base
- 3 locking lever (arm angle/feeder height)
- 4 locking lever (feeder rotation)
- 5 arm holder
- 6 control wheel of arm protrusion (turning moves the arm)
- 7 locking lever (arm protrusion)
- 8 feeder arm
- 9 motor
- 10 locking lever (joint of the feeder body)
- 11 feed roller

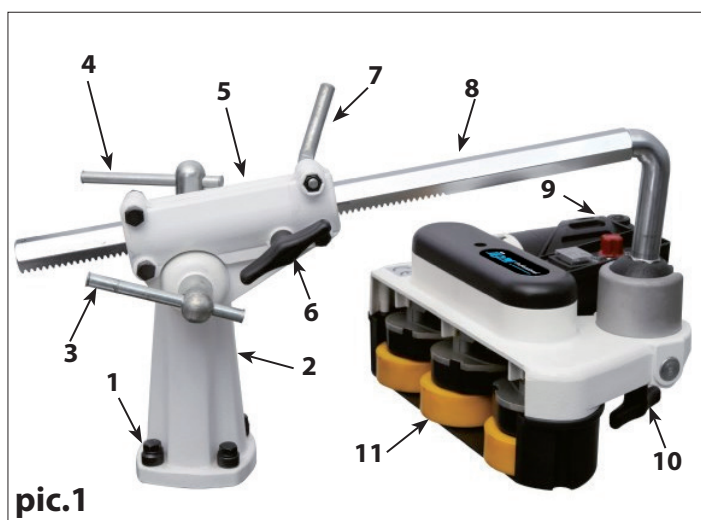

### 4.2 Technical data

Motor power (230V)	95 W
Arm reach	260 mm
Max. workpiece height	150 mm
No. of rollers	3
Size of rollers	76 x 30 mm
Feed speed	2 - 12 m/min
Weight with stand	10,5 kg

### 4.3 The package includes

The M3M Power  
Feeder,  
Feeder Arm,  
Feeder base  
plan for base drilling 1:1  
manuál

## 5. TRANSPORT, UNPACKING AND ASSEMBLY

### 5.1 Transport and unpacking

The machine is not assembled due to transport.  
Assemble before operating. Remove the edgebander from the packaging and place on a flat surface. Check for any apparent transport damages, these could damage the machine or your health.

## 5.2 Assembly

### 5.2.1 Fastening to a machine

A) using a quick fit universal plate

- you can fasten the feeder to the machine using a quick fit universal plate (not included), (pic.2).

B) Mounting to the top of a workbench

The feeder is supplied with a 1:1 template that facilitates the mounting of the feeder onto a base (Pic. 3).

1. Unpack the feeder base and adjust it according to the mounting template.
2. Prepare 4 bolts and spring washers (not included). Bolt size - M10, length = feeder base (thickness) + table top (thickness)
3. Select position of the base to avoid ribbing on the bottom of the table.
4. Place the template on the table, use a tape to hold two sides of the template
5. Use a sharp object to mark out the holes and drill them out.

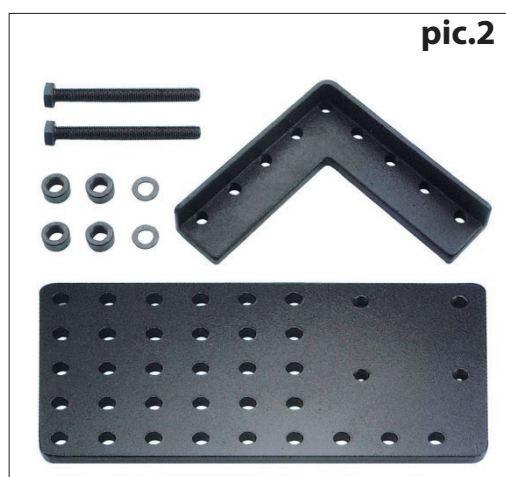

B.1) Fastening with a nut through the table

1. Insert the screws with washers through the base and the tabletop.
2. Tighten the nut to the table.

B.2) Fastening with a thread in the table

1. Use a screw cutter to drill out the holes.
2. Insert the screws with washers through the base and screw it them into the tabletop.

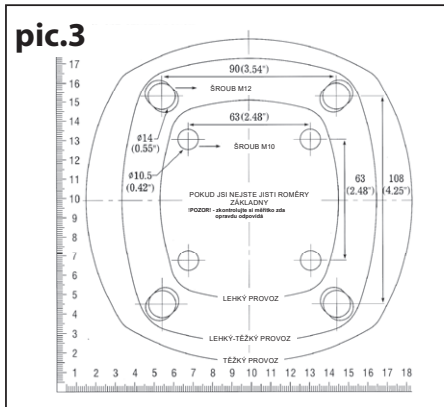

pic.3

- Secure the joint with the lever (15D-3, pic.6). Push the pipe (17D-1) through the openings on the side and use it to tighten the foot using the wing screw 17D-2 (pic.6)

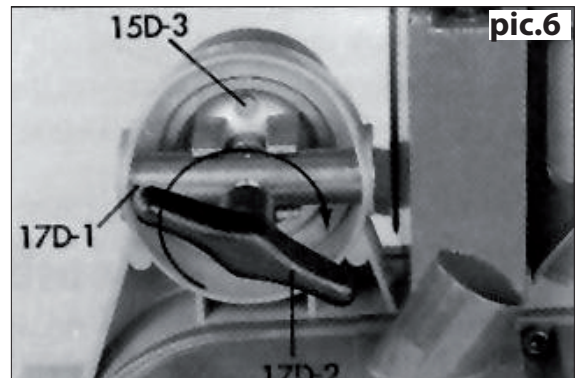

pic.6

### 5.2.2 Feeder assembly (pic.4)

- Mount the swivel joint (3) onto the stand (2) and screw in using the lever (4).

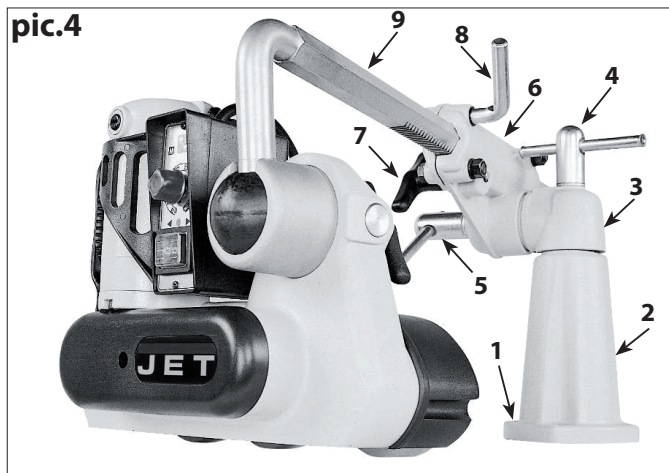

pic.4

- Disassemble the arm holder  
- Place the part with a lever on the feeder arm and load the gear. (pic.7)

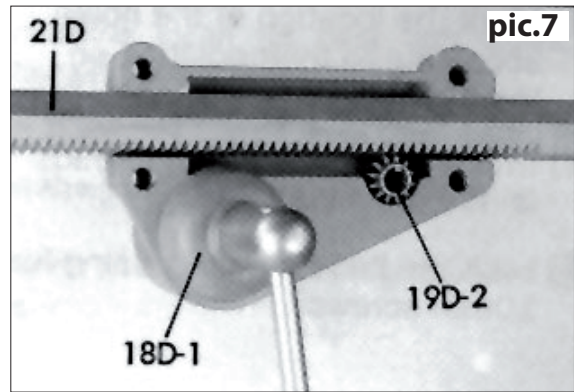

pic.7

- Assembly of the joint part of the arm.  
Push the arm with a joint through the metal grommet.  
So that the joint stays in the grommet. (pic.5)

- Use three screws (18D-3, pic.8) to cover the arm holder.

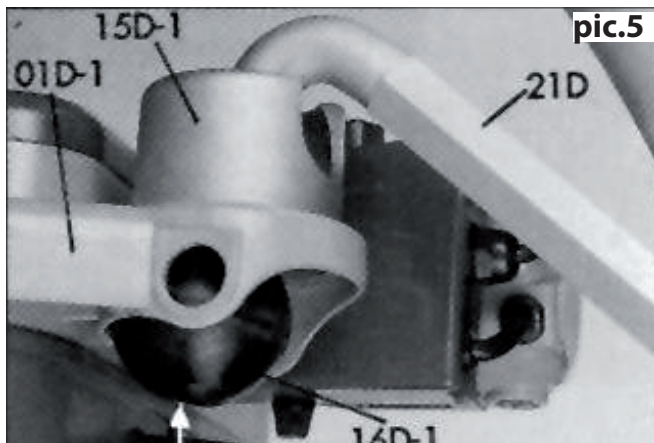

pic.5

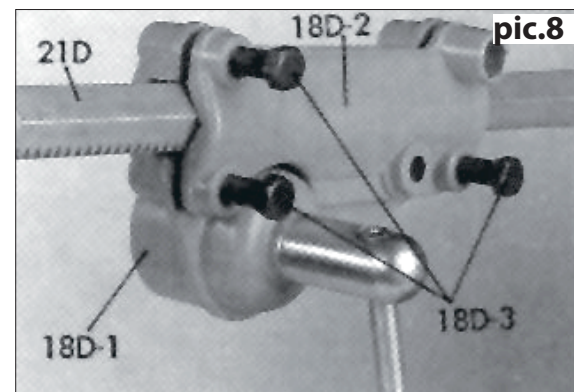

pic.8

- Fit the thumbscrew through the opening with a gear. (pic.9)

- Place the locking lever into the free opening on the arm holder and secure with a nut.

Screw the locking lever into the nut. (pic.10)

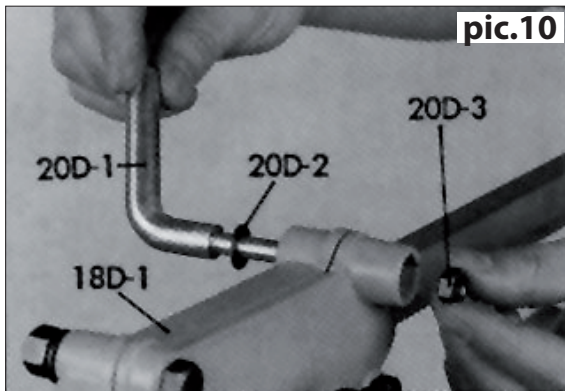
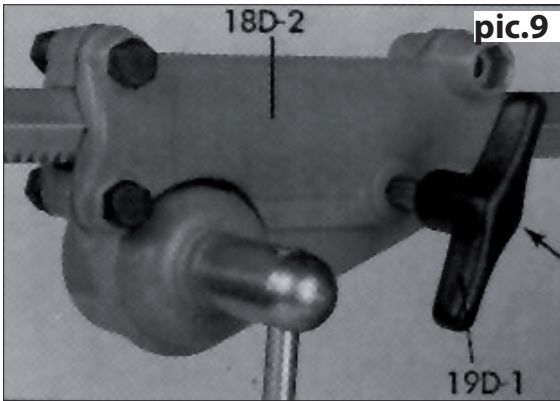

- Mount the arm holder onto the rotating joint and tighten the locking lever (5, pic.4)

### 5.3 Power supply

**WARNING:** Make sure the electrical connection corresponds to the motor specification (see engine cover.) **WARNING:** Make sure the switch is in the „OFF“ position.

- Power cable for 230 V/50 Hz.
- Surge fuse 10 A.

Use a separate electrical circuit to connect the feeder. The electrical connection parameters are listed on the label on the back side of the motor. Make sure the main switch is in the off position before connecting the feeder to the power supply. The voltage in the electric socket must be identical to the parameters on the motor label. Make sure all the cables, plugs and extensions are properly contacted and are not damaged. Insufficient voltage may cause damage to the motor.

### Grounding

The feeder must be grounded to prevent electrical shock. The power cord must be plugged into a grounded socket. The plug must comply with local standards for electrical safety. When using an extension cord, make sure it is grounded. Regularly check that the cable is not damaged.

### Damaged electric cord must be replaced immediately.

If you are ever in doubt whether the power cord is properly grounded, let a qualified electrician check the cable.

### 5.4 Dust extraction

The feeder can be connected to dust extraction. The extraction hoses can be connected directly to the nozzle on the feeder, see pictures 11 and 12. The outer diameter of the nozzle is 34 mm and the inner one is 30,6 mm.

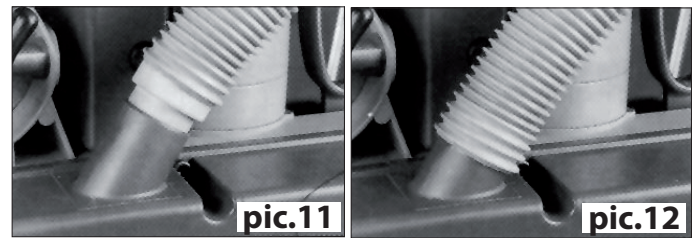

## 6. SET-UP AND ADJUSTMENT

### 6.1 Basic movements of the feeder

- Release the locking lever (A, pic.13), and rotate the feeder to the desired position.

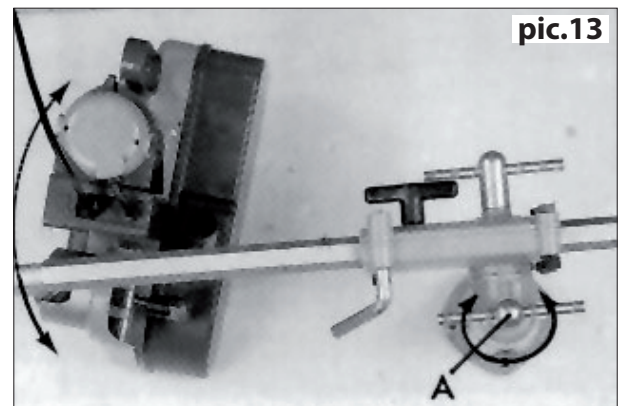

- Release the locking lever (K, pic.14) and move the feeder front or back by turning the lever (P).

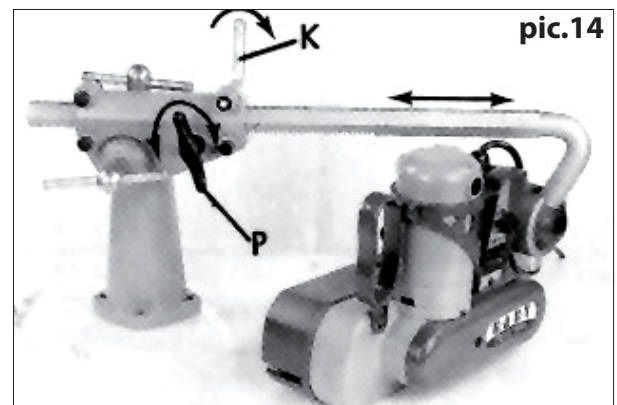

- Release the locking lever (B, pic.15) and set the height of the feeder.

**Warning:** Before releasing the lever (B), make sure you are preventing the feeder to fall over. Otherwise, it can suddenly fall and cause an injury or damage itself.

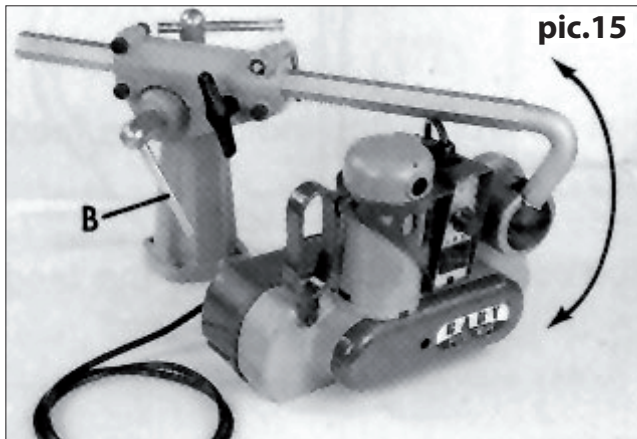

- If you release the lever (C, pic.16), you can rotate the feeder in the joint.

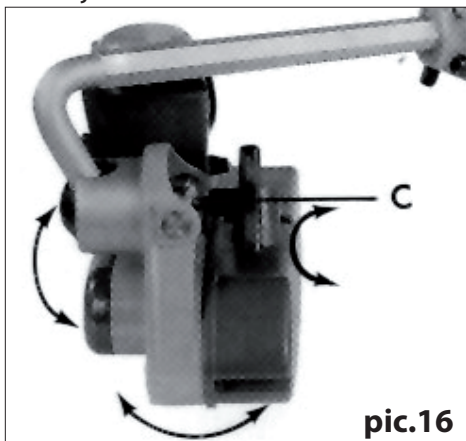

**Warning:** Always make sure all levers are properly tightened before turning on the feeder.

### 6.1.1 Feeding from above

It is important that the feeder creates constant pressure against the fence when feeding from above

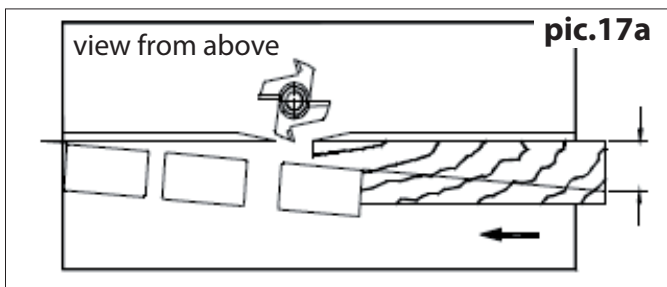

### 6.1.2 Feeding from the side

- Release the lever (C, pic.16) turn the feeder to a vertical position and tighten the lever (C).

The rollers must push the workpiece against the fence. The difference between the distance of the feeder and the fence should be greater on the infeed roller by 3-4 mm than on the outfeed roller (pic. 17b).

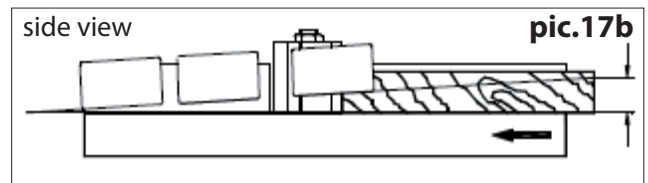

## 6.2 Controls

- The feeder has a switch (1), that indicates the feed direction. The feeding is turned off when in the middle position.
- The control wheel (2) is used to regulate the feed speed within the range of 2-12 m/min.
- The control wheel can be used as a power switch, it will halt the feed when pushed. Pull it to restart the feed.

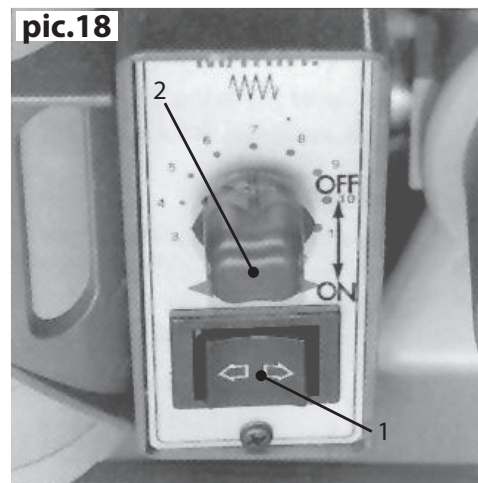

## 7. OPERATING THE MACHINE

After switching the machine on, let the feeder reach its full speed before feeding any material.

## 8. MAINTENANCE AND CONTROL

### 8.1 Replacing rollers

Any adjustments and maintenance may be carried out when the machine is disconnected from the power source.

#### Note:

The regular switch up of roller position grants longer life of the rollers.

- The workpiece must be leaning on a guiding fence when feeding.

Take off the front cover of the rollers. Remove the circlip (C, pic.19) and remove the roller. Insert a new roller into the original position. Mount the circlip (C).

- Use the D76x30 mm roller for the M3 Power Feeder.

(code: 141-R76)

pic.19

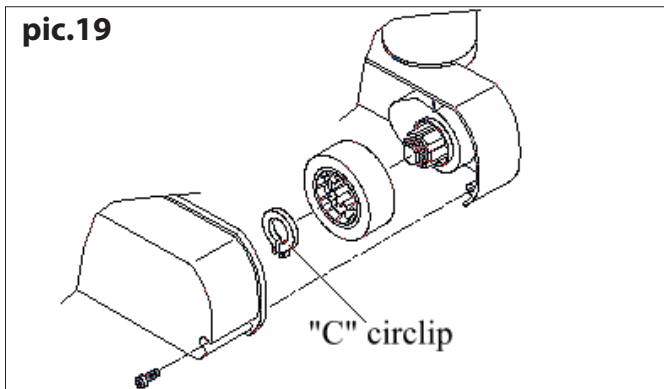

## 8.2 Lubrication

- The wheels should be lubricated every 200 hours of operation or 30 days through their parts using a grease gun.

- Recommended greases: (Shell – Alvania Grease R2, SHELL GADUS S2 V220 2, MOBILUX EP 2; FUCHS RENOLIT EP 2; BP ENERGREASE MM-EP 2 and other.)

## 9. MALFUNCTION ASSISTANCE

- If you are not sure why a problem occurred, please contact technical support.

## 10. PROTECTION OF THE ENVIRONMENT

Protect the environment.

Your machine contains materials that can be recycled.

Please, let specialized institutions handle the machine.

## 11. ACCESSORIES (SPARE PARTS)

IGM Spare Roller D76x30 for the M3 Feeder **141-R76**

IGM Quick Fit Universal Plate for M3, AF32 Feeders **141-DP**